

# Retro Revolution horizontal

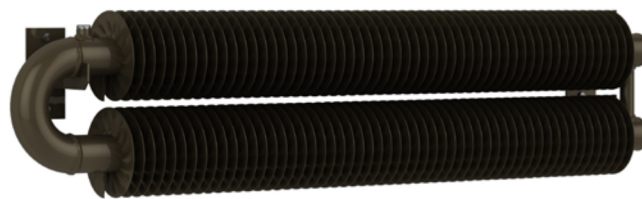

## ocelové radiátory z žebrových trubek

Retro radiátory jsou oblíbeny architektky a interierovými designéry. Jejich předností je dlouhá životnost, variabilita. Nadefinujte si tvar a postavení trubek dle potřeb interiéru od délky půl metru až po šest metrů, s možností umís-tění až šesti trubek nad sebou. Retro Revolution jsou našimi zákazníky využívány v administrativní výstavbě, restauracích, hotelových lobby, technických, ale i hospodářských budovách.



Retro Revolution WO - II  
HOTHOT 83

### Základní specifikace

Materiál	ocel. trubky s návinem z ocelových pásů
Průměry	Ø 57×2,5 × Ø 137 mm
Připojovací závit	vnitřní 2×G1/2"
Zkušební přetlak	1,3 MPa (13 bar)
Max. provozní přetlak	1,0 MPa (10 bar)
Max. provozní teplota	120 °C

### Retro Revolution

typ/délka	Hloubka	Výška	Teplotní exponent	Výkon 55/45/20°C	Výkon 70/55/20°C	Výkon 75/65/20°C
[mm]	[mm]	[mm]	[-]	[W]	[W]	[W]
WR,SR,FR/500	137	237	1	89	140	173
ST,FT - II/500	137	383	1	148	231	285
ST,FT - III/500	137	529	1	208	324	398
WR,SR,FR/1000	137	237	1	184	289	356
ST,FT - II/1000	137	383	1	316	494	608
ST,FT - III/1000	137	529	1	443	690	849
WR,SR,FR/1500	137	237	1	281	441	544
ST,FT - II/1500	137	383	1	493	770	948
ST,FT - III/1500	137	529	1	691	1076	1324
WR,SR,FR/2000	137	237	1	380	596	735
ST,FT - II/2000	137	383	1	676	1055	1299
ST,FT - III/2000	137	529	1	946	1475	1814





## Retro Revolution



Připojení 50 mm, možné u modelů FR, FT, SR, ST, WR, WT.

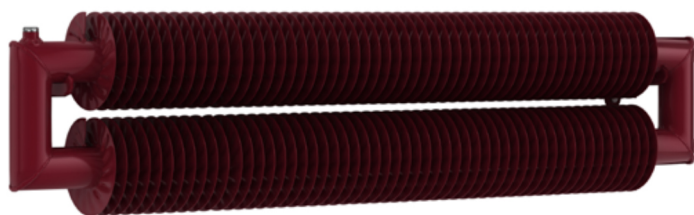

Retro Revolution WT - II  
RAL 3032

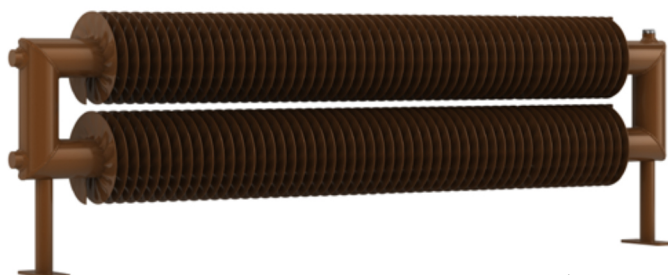

Retro Revolution FT - II  
HOTHOT 62



# Retro Revolution

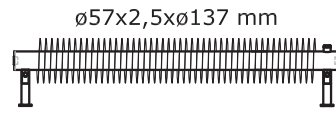
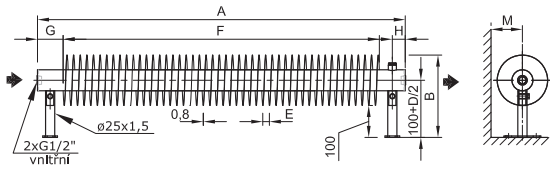

ø57x2,5xø137 mm



	Rozměry [mm]												
	A	B	C	D	E	F	G	H	I	J	K	L	M
ø57 x 2,5 x ø137 mm	500 - 6000	237	57	137	18	A-140	70	35	-	-	-	-	≥85

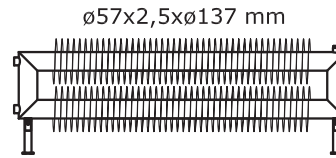
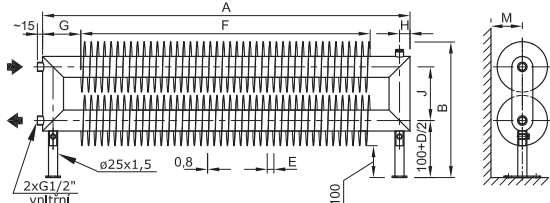

ø57x2,5xø137 mm

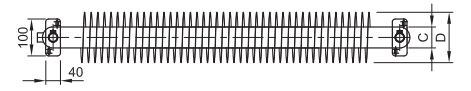

	Rozměry [mm]												
	A	B	C	D	E	F	G	H	I	J	K	L	M
ø57 x 2,5 x ø137 mm	500 - 6000	383	57	137	18	A-220	110	28	-	146	-	-	≥85

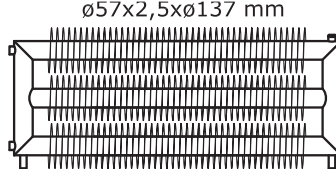
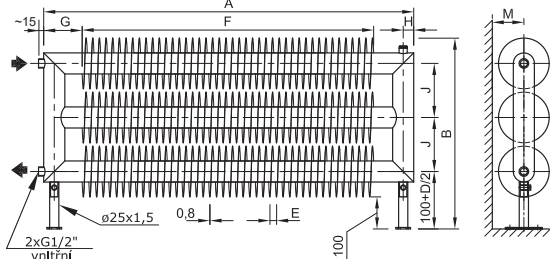

ø57x2,5xø137 mm

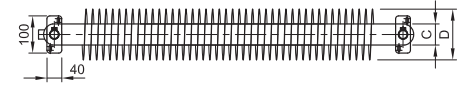

	Rozměry [mm]												
	A	B	C	D	E	F	G	H	I	J	K	L	M
ø57 x 2,5 x ø137 mm	500 - 6000	529	57	137	18	A-220	110	28	-	146	-	-	≥85

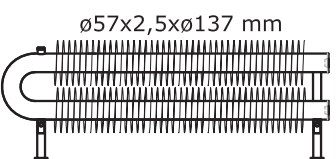
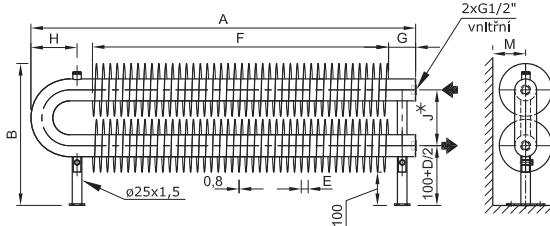

ø57x2,5xø137 mm

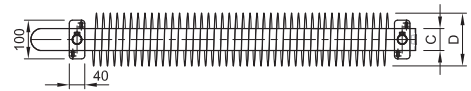

	Rozměry [mm]												
	A	B	C	D	E	F	G	H	I	J	K	L	M
ø57 x 2,5 x ø137 mm	500 - 6000	382	57	137	18	A-230	70	120	-	145	-	-	≥85

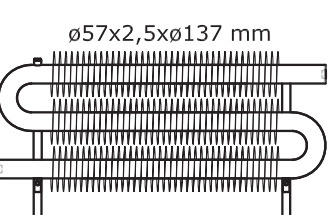
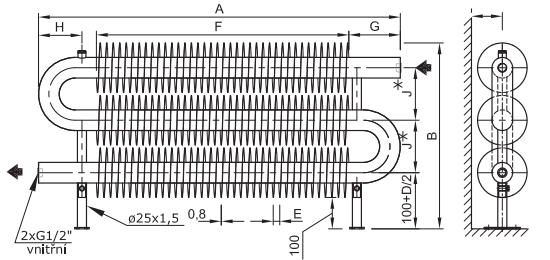

ø57x2,5xø137 mm

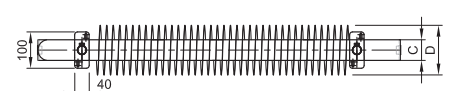

	Rozměry [mm]												
	A	B	C	D	E	F	G	H	I	J	K	L	M
ø57 x 2,5 x ø137 mm	500 - 6000	527	57	137	18	A-300	150	120	-	145	-	-	≥85

# Retro Revolution

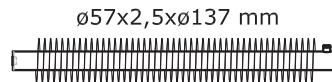
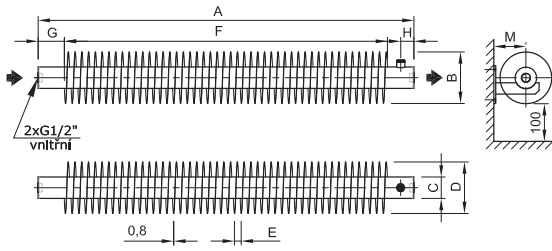

Ø57 x 2,5 x Ø137 mm	Rozměry [mm]												
	A	B	C	D	E	F	G	H	I	J	K	L	M
Ø57 x 2,5 x Ø137 mm	500 - 6000	D	57	137	18	A-140	70	35	-	-	-	-	85

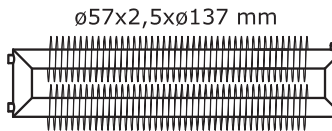
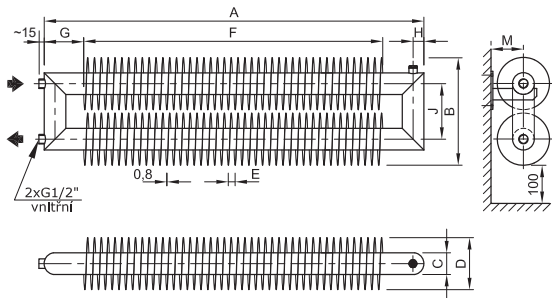

Ø57 x 2,5 x Ø137 mm	Rozměry [mm]												
	A	B	C	D	E	F	G	H	I	J	K	L	M
Ø57 x 2,5 x Ø137 mm	500 - 6000	283	57	137	18	A-220	110	28	-	-	-	-	85

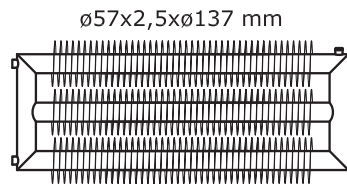
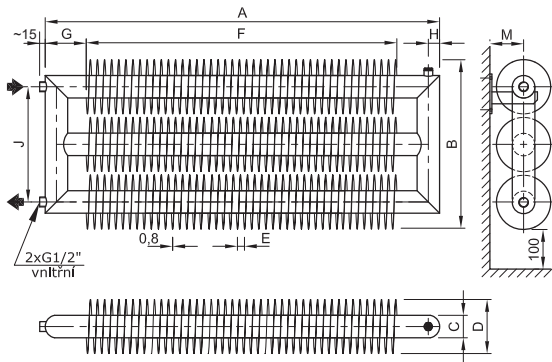

Ø57 x 2,5 x Ø137 mm	Rozměry [mm]												
	A	B	C	D	E	F	G	H	I	J	K	L	M
Ø57 x 2,5 x Ø137 mm	500 - 6000	429	57	137	18	A-220	110	28	-	292	-	-	85

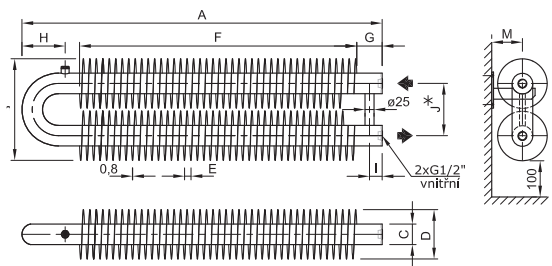

Ø57 x 2,5 x Ø137 mm	Rozměry [mm]												
	A	B	C	D	E	F	G	H	I	J	K	L	M
Ø57 x 2,5 x Ø137 mm	500 - 6000	282	57	137	18	A-230	70	120	-	145	-	-	85

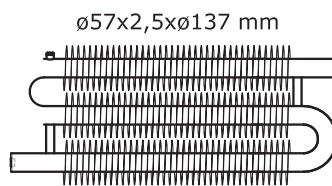
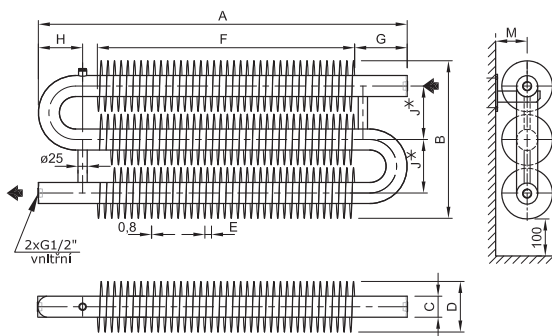

Ø57 x 2,5 x Ø137 mm	Rozměry [mm]												
	A	B	C	D	E	F	G	H	I	J	K	L	M
Ø57 x 2,5 x Ø137 mm	500 - 6000	427	57	137	18	A-300	150	120	-	145	-	-	85

# Retro Revolution

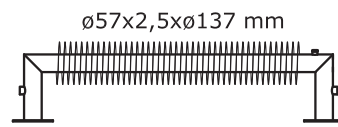
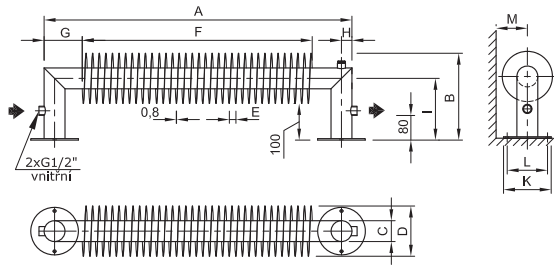

	Rozměry [mm]												
	A	B	C	D	E	F	G	H	I	J	K	L	M
$\varnothing 57 \times 2,5 \times \varnothing 137 \text{ mm}$	500 - 6000	237	57	137	18	A-220	110	28	169	-	130	110	$\geq 85$

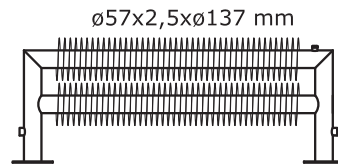
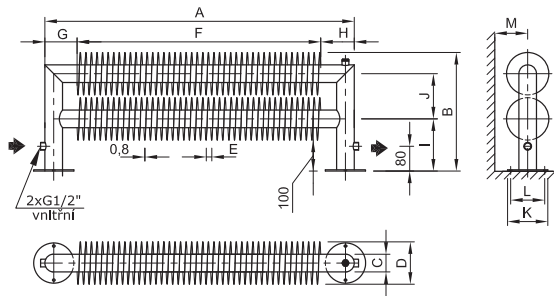

	Rozměry [mm]												
	A	B	C	D	E	F	G	H	I	J	K	L	M
$\varnothing 57 \times 2,5 \times \varnothing 137 \text{ mm}$	500 - 6000	383	57	137	18	A-220	110	28	169	146	130	110	$\geq 85$

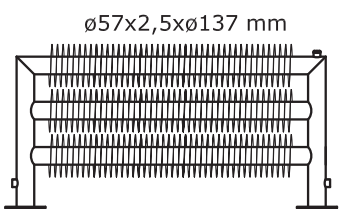
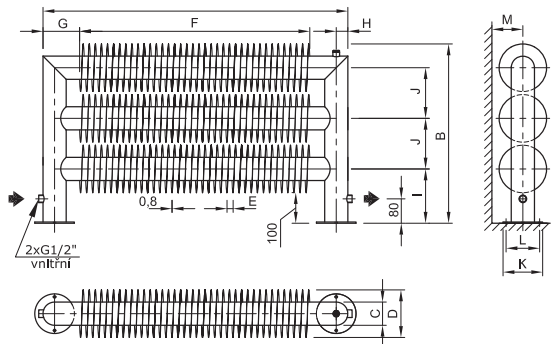

	Rozměry [mm]												
	A	B	C	D	E	F	G	H	I	J	K	L	M
$\varnothing 57 \times 2,5 \times \varnothing 137 \text{ mm}$	500 - 6000	529	57	137	18	A-220	110	28	169	146	130	110	$\geq 85$