

Retro Revolution

horizontal



steel radiators made of finned tubes

Retro radiators are popular with architects and interior designers. Their advantages are: long life, variability. Define the shape and position of the pipes according to the needs of the interior from a height of half a meter to six meters, with the possibility of placing up to three pipes next to each other. Radiators Retro Revolution are used by our customers in administrative construction, restaurants, hotel lobbies, technical as well as farm buildings.

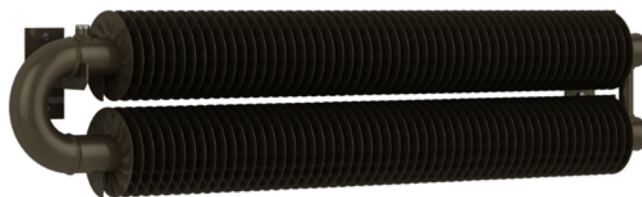

Retro Revolution WO- II
HOTHOT83

Basic specifications

Material:	steel tubes with steel strips
Diameters:	Ø57× 2,5 × Ø 13mm
Connection threads:	inner 2×G1/2"
Testing overpressure:	1,3 MPa (13 bar)
Max. operating overpressure:	1,0 MPa (10 bar)
Max. operating temperature:	120 °C

Retro Revolution

Type/height	Depth	Width	Temperature exponent	Heating Output		
				55/45/20°C	70/55/20°C	75/65/20°C
[mm]	[mm]	[mm]	[-]	[W]	[W]	[W]
WR,SR,FR/500	137	237	1	89	140	173
ST,FT - II/500	137	383	1	148	231	285
ST,FT - III/500	137	529	1	208	324	398
WR,SR,FR/1000	137	237	1	184	289	356
ST,FT - II/1000	137	383	1	316	494	608
ST,FT - III/1000	137	529	1	443	690	849
WR,SR,FR/1500	137	237	1	281	441	544
ST,FT - II/1500	137	383	1	493	770	948
ST,FT - III/1500	137	529	1	691	1076	1324
WR,SR,FR/2000	137	237	1	380	596	735
ST,FT - II/2000	137	383	1	676	1055	1299
ST,FT - III/2000	137	529	1	946	1475	1814



Retro Revolution



Connection 50 mm, possible on models: FR,FT,SR,ST,WR, WT.

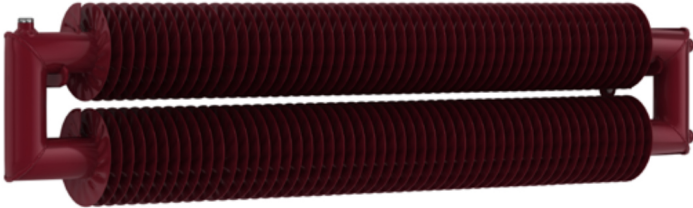

Retro Revolution WT- II
RAL3032

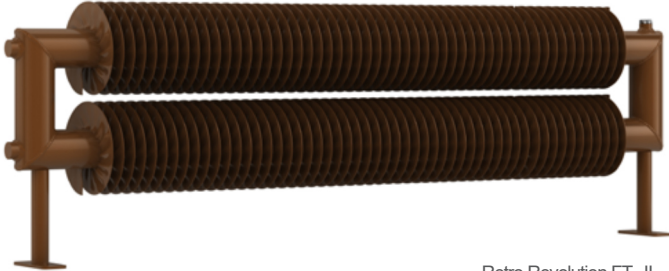

Retro Revolution FT- II
HOTHOT 62



Retro Revolution

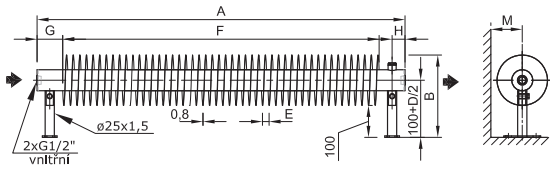

Ø57x2,5xØ137mm	Dimensions [mm]												
	A	B	C	D	E	F	G	H	I	J	K	L	M
	500-6000	237	57	137	18	A-140	70	35	-	-	-	-	≥85

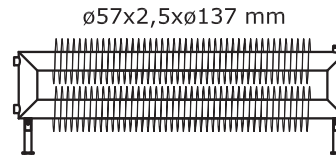
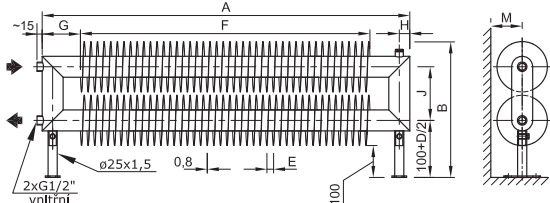

Ø57x2,5xØ137mm	Dimensions [mm]												
	A	B	C	D	E	F	G	H	I	J	K	L	M
	500-6000	383	57	137	18	A-220	110	28	-	146	-	-	≥85

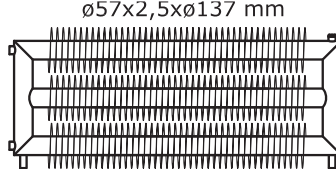
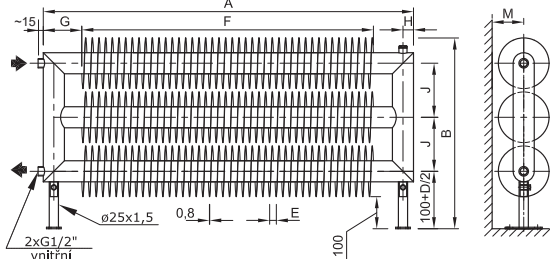

Ø57x2,5xØ137mm	Dimensions [mm]												
	A	B	C	D	E	F	G	H	I	J	K	L	M
	500-6000	529	57	137	18	A-220	110	28	-	146	-	-	≥85

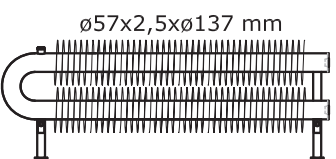
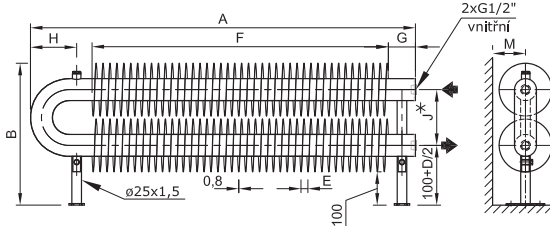
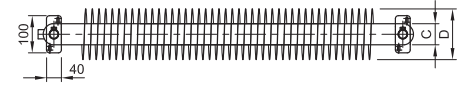

Ø57x2,5xØ137mm	Dimensions [mm]												
	A	B	C	D	E	F	G	H	I	J	K	L	M
	500-6000	382	57	137	18	A-230	70	120	-	145	-	-	≥85

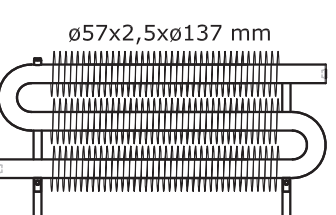
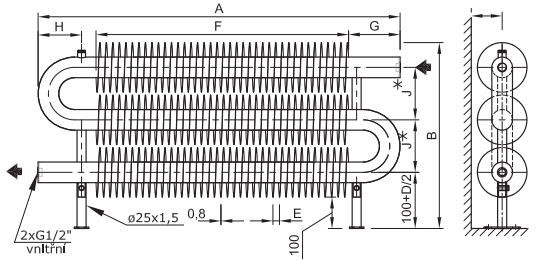

Ø57x2,5xØ137mm	Dimensions [mm]												
	A	B	C	D	E	F	G	H	I	J	K	L	M
	500-6000	527	57	137	18	A-300	150	120	-	145	-	-	≥85

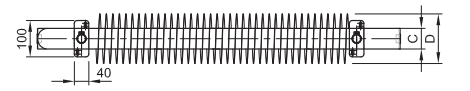

Retro Revolution

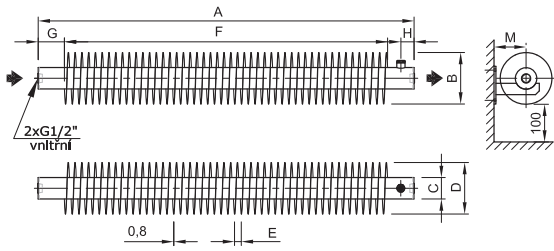

	Dimensions [mm]												
	A	B	C	D	E	F	G	H	I	J	K	L	M
$\varnothing 57 \times 2,5 \times \varnothing 137 \text{ mm}$	500-6000	D	57	137	18	A-140	70	35	-	-	-	-	85

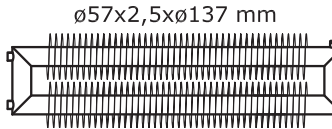
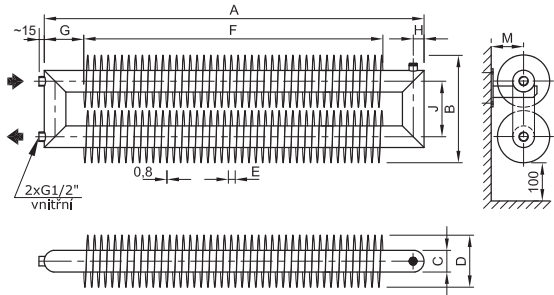

	Dimensions [mm]												
	A	B	C	D	E	F	G	H	I	J	K	L	M
$\varnothing 57 \times 2,5 \times \varnothing 137 \text{ mm}$	500-6000	283	57	137	18	A-220	110	28	-	-	-	-	85

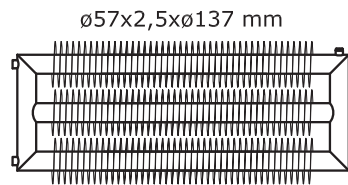
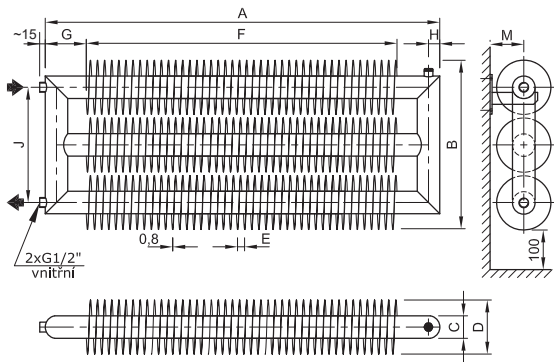

	Dimensions [mm]												
	A	B	C	D	E	F	G	H	I	J	K	L	M
$\varnothing 57 \times 2,5 \times \varnothing 137 \text{ mm}$	500-6000	429	57	137	18	A-220	110	28	-	292	-	-	85

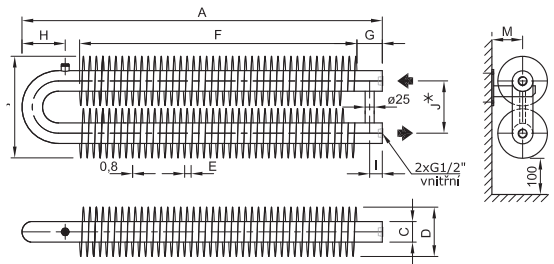

	Dimensions [mm]												
	A	B	C	D	E	F	G	H	I	J	K	L	M
$\varnothing 57 \times 2,5 \times \varnothing 137 \text{ mm}$	500-6000	282	57	137	18	A-230	70	120	-	145	-	-	85

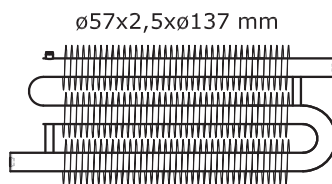
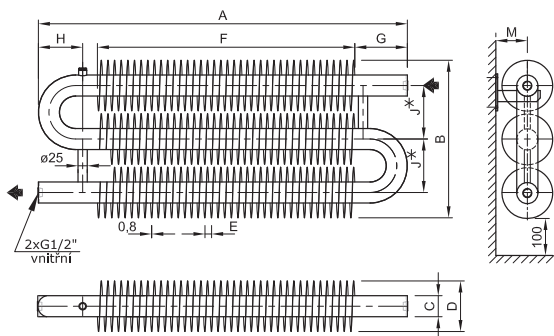

	Dimensions [mm]												
	A	B	C	D	E	F	G	H	I	J	K	L	M
$\varnothing 57 \times 2,5 \times \varnothing 137 \text{ mm}$	500-6000	427	57	137	18	A-300	150	120	-	145	-	-	85

Retro Revolution

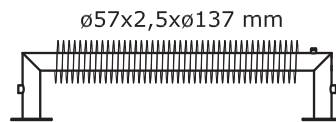
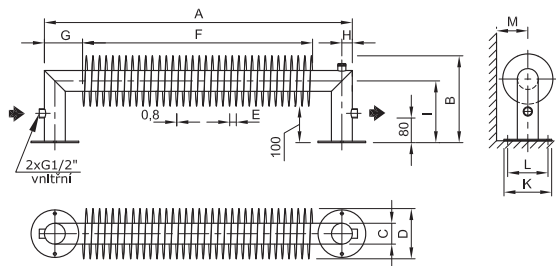

	Dimensions[mm]													
	A	B	C	D	E	F	G	H	I	J	K	L	M	
Ø57x2,5xØ137mm	500-6000	237	57	137	18	A-220	110	28	169	-	130	110	≥85	

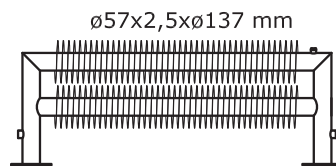
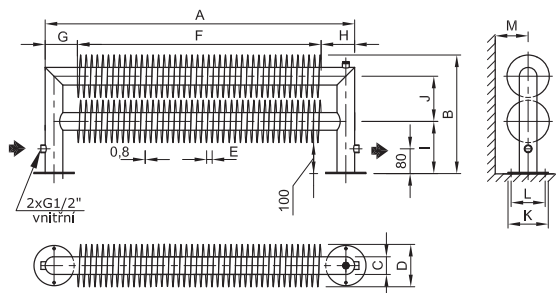

	Dimensions[mm]													
	A	B	C	D	E	F	G	H	I	J	K	L	M	
Ø57x2,5xØ137mm	500-6000	383	57	137	18	A-220	110	28	169	146	130	110	≥85	

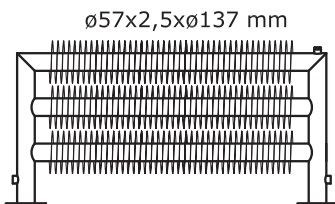
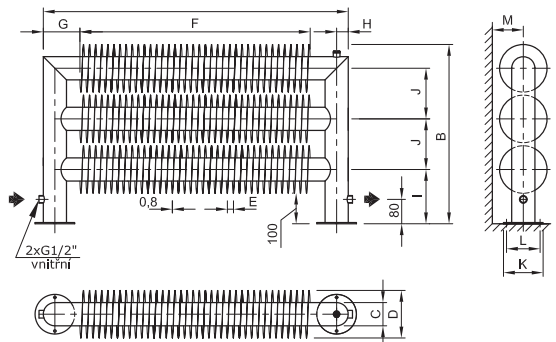

	Dimensions[mm]													
	A	B	C	D	E	F	G	H	I	J	K	L	M	
Ø57x2,5xØ137mm	500-6000	529	57	137	18	A-220	110	28	169	146	130	110	≥85	